



Pittsburgh **PARKING** Authority

The Value Parking Network

GENERAL INFORMATION REGARDING THE FORBES SEMPLE GARAGE

210 MEYRAN AVENUE, PITTSBURGH, PA 15213

The Forbes Semple Garage is an eight-level structure located in the Oakland Business District of the City of Pittsburgh.

The single helix design has one-way traffic flow with a dedicated single helix exit ramp.

The garage was opened in 1978 and accommodates 449 vehicles.

The Forbes Semple Garage structural system consists of cast-in-place, post-tensioned concrete slabs supported by structural steel beams and columns.

You can enter and exit the garage from Meyran Avenue, which is a half block off of Forbes Avenue in Oakland.

Total Area of garage:	169,695 sf.
Typical Floor area:	20,939 sf.
Maximum Dimensions:	240' x 140'
Typical Bay Dimensions:	57'-11" x 20'-7 1/2"
Architectural Shape:	Irregular
Year Opened:	1978
Number of Levels:	8 structurally supported + 1 slab-on-grade
Total Number of Spaces in garage:	449
Parking on Grade:	Yes
Retail Space within garage:	No
Below Grade parking:	Yes
Construction Type:	Cast-in-place, post-tensioned slabs, structural steel beams and columns
Garage Functionality:	One-way single helix with express helix exit ramp
Maximum Clearance Height:	6'6"

SEE NEXT PAGE: FORBES SEMPLE GARAGE TYPICAL FLOOR PLAN

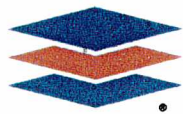

Pittsburgh **PARKING** Authority

The Value Parking Network

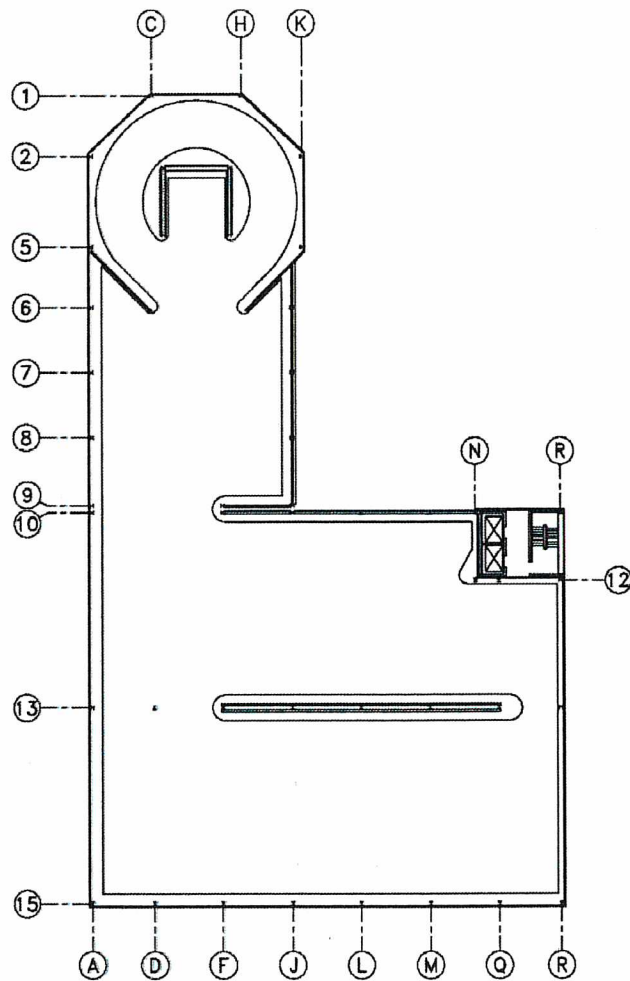

FORBES SEMPLE PARKING GARAGE ➔➔➔ N
TYPICAL FLOOR PLAN